

WA-EVC-4P-25A (AC MODULAR CONTACTOR)

The WA-EVC-4P-25A is a 4 pole 25 amperes modular contactor ideal for switching loads in domestic and industrial applications.

With 400V rated voltage and 25A rated current the contactor is ideally suited for applications with 230V AC control voltage

that require rapid switching (<40ms). An example of such applications is switching of Electric Vehicles in EV Charging stations.

The Contactor is certified to IEC/EN60947-4-1.

MAIN FEATURES

- 4 normally open contacts
- AC-1 25A / AC-3 9A contacts
- 230V AC control voltage
- Quick Opening (<40ms)
- Modular Din Rail Mounting
- Certified to IEC/EN 60947-4-1

Contacts Arrangement

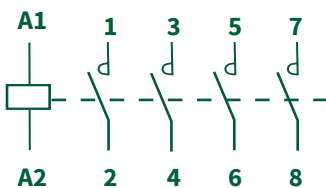

Order Code: 90160

Image for illustration purposes only

SEE ALSO

WA-EVC-4P-40A	AC Modular Contactor – 4 Pole 40A
WA-EVC-2P-40A	AC Modular Contactor – 2 Pole 40A
WA-EVC-2P-25A	AC Modular Contactor – 2 Pole 25A
EVCC-01	EV Charger Controller for Mode 3 EVSE

TECHNICAL DATA

Relevant Product Standard	IEC/EN 60947-4-1
Utilization Category	AC-1 25A / AC-3 9A
Rated Control Circuit Supply Voltage (Us)	230/240V AC 50/60Hz
Rated Control Circuit Voltage (Uc)	230/240V AC 50/60Hz
Rated Operational Voltage (Ue)	400/415V AC 50/60Hz
Rated Insulation Voltage (Ui)	500V AC
Rated Impulse Withstand Voltage (Uimp)	4kV
Contactors Width	36mm
Environmental Operating Conditions	-5°C to +55°C

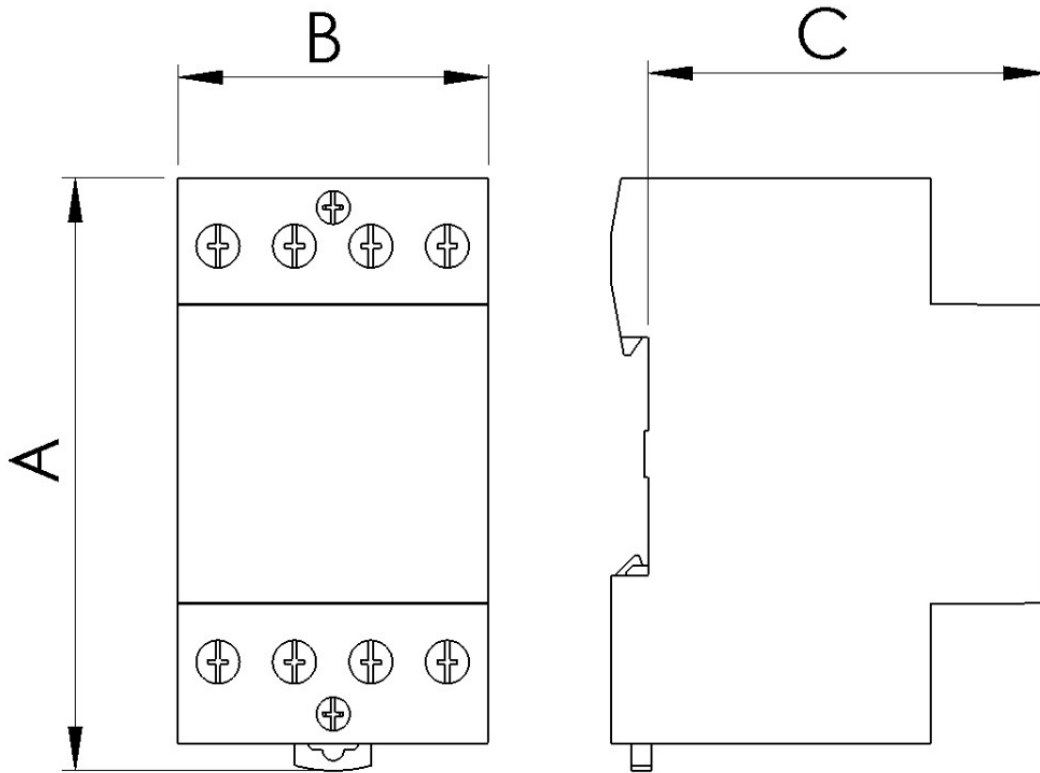

DIMENSION	VALUE (MAX)
A	85
B	36
C	68

*All dimensions in mm.
Image for illustration purposes only*

Disclaimer: Whilst every effort has been made to ensure the technical accuracy of this document, changes may be made to the document without notice based on information received by WA which necessitate such changes. WA ensures compliance of its products/technology with Product Standards relevant to the WA technology. However, the User of our products/technology has the sole responsibility to ensure that any Product that they produce which uses WA technology complies with the relevant Product Standards and Installation Rules as applicable to the end Product using the WA technology.